



DJI OSMO ACTION 2

TILTA

DJI ACTION 2 相机拓展套件



01 免责声明和警告

感谢您购买TILTA产品。

使用本产品之前,请仔细阅读本文以确保已对产品进行正确的设置。本文档及本产品所有相关的文档最终解释权归TILTA所有。如有更新,恕不另行通知。请访问www.tilta.com官方网站以获取最新的产品信息。

一旦使用本产品,即视为您已经仔细阅读免责声明与警告,理解、认可和接受本声明全部条款和内容。您承诺对使用本产品以及可能带来的后果负全部责任。您承诺仅出于正当目的使用本产品,并且同意本条款以及TILTA制定的任何相关条例、政策和指引。

TILTA对于直接或间接使用本产品而造成的损坏、伤害以及任何法律责任不予负责。用户应遵循包括但不限于本文提及的所有安全指引。

即使存在上述规定,消费者权益依然受当地法律法规所保障,并不受本免责声明影响。

TILTA是深圳市铁头科技有限公司及其关联公司的商标。本文出现的产品名称、品牌等,均为其所属公司的商标或注册商标。

02 认识 — Action 2 相机拓展套件

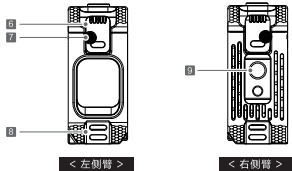
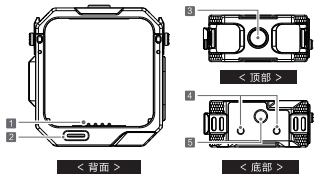

- | | | |
|------------|----------|----------|
| 1 供电接口 | 4 M3螺纹孔 | 7 拨钮 |
| 2 Type-c接口 | 5 1/4螺纹孔 | 8 挂绳孔 |
| 3 电源/拍摄按键 | 6 锁扣 | 9 1/4定位孔 |

安装说明

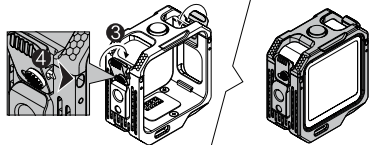
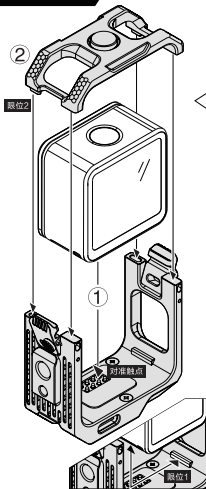

将DJI Action 2 主机装入单体免壳中①(需对准“触点”和“限位1”), 再对准“限位2”装上顶部上盖②。按图示3操作, 压紧锁扣并滑动拨钮④锁紧。拆卸时松开拨钮并拨动锁扣再取下即可。

细节展示

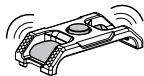

顶部和底部都有导热硅胶垫, 让散热更快捷。
顶部开机按钮, 增加了操作的舒适度。
侧边边窗, 保证WIFI信号无遮挡。

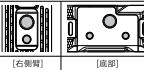

底部和侧面同时具有1/4螺纹孔, 可以装三脚架/钢牛云台等, 也可直接连接到底座, 实现横竖拍切换。
底部预留2个M3螺丝孔, 可以装gopro底座。

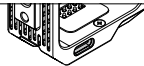

背面带有Type-c 接口供电, 可以实现更长时间的拍摄。

03 认识—Action 2 续航/双屏拓展套件

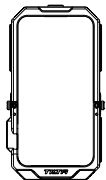

< 正面 >

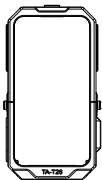

< 背面 >



< 底部 >

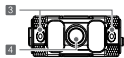

< 顶部 >

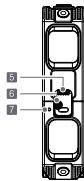

< 左侧臂 >

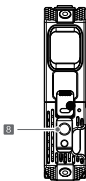

< 右侧臂 >

- 1 M3螺纹孔
- 2 1/4螺纹孔
- 3 M3螺纹孔
- 4 电源/拍摄按键
- 5 锁扣
- 6 拨钮
- 7 音频孔
- 8 1/4定位孔

安装说明

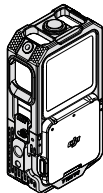
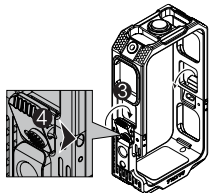
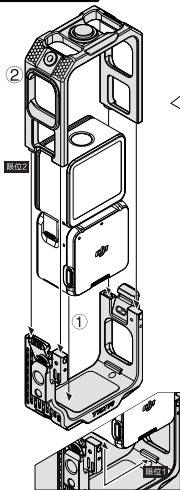

将DJI Action 2 主相机和前屏拓展模块装入组合免笼中①(根据type-c的接口确定安装方向, 对准“限位1”, 再对准“限位2”装上顶部上盖②。按图示3操作, 压紧锁扣并滑动拨钮④锁紧。拆卸时松开拨钮并拨动锁扣再取下即可。

细节展示



顶部和底部都有导热硅胶垫, 让散热更快捷。
顶部开机按钮, 增加了操作的舒适度。
侧边边窗, 保证WiFi信号无遮挡。



[顶部]



[底部]

斜角预留4个M3螺丝孔。
用来装配减震支架。

04 认识—减震支架套装

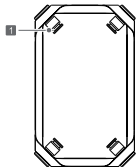

< 正面/背面 >



< 左侧臂 >

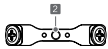

< 顶部 >

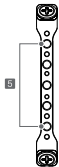

< 右侧臂 >

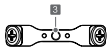

< 底部 >

1 减震软胶垫
[减弱震动的频率]

2 3 4 5 1/4定位孔
[预留多个扩展孔,可实现横竖拍
也可安装补光灯/图传等设备。]

安装说明

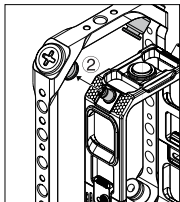
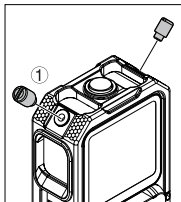
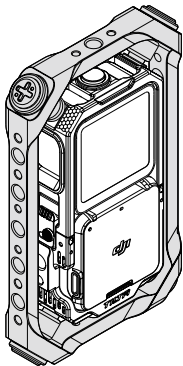

将M3螺丝装进续航/双屏拓展套件四周拐角的M3螺纹孔上**①**,
再将续航/双屏拓展套件上的M3螺丝柱依次推进减震软胶垫里**②**,
完成装配后再整体检查固定性即可使用。

05 安装滤震支架的软管管卡

如果需要高速拍摄场景时,可使用软管管卡,让套件更加稳定。

先将软管管卡①套在滤震支架的软胶垫卡口上,再将②续航/双屏拓展套件的4个M3螺丝柱推进软胶垫里完成装配。

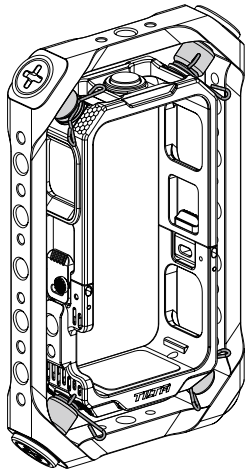
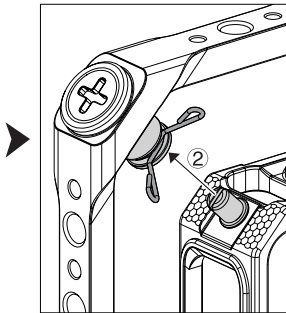
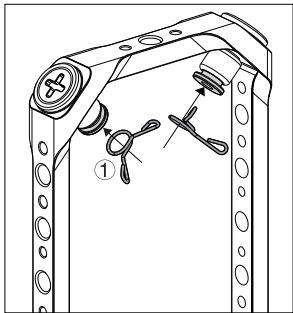

06 安装磁吸扩展底座

扩展底座底部带磁性，可直接磁吸在铁质产品上。

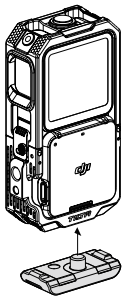
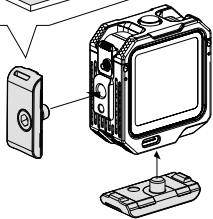
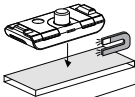

磁吸扩展底座安装在单体兔笼或组合体兔笼的1/4螺纹孔上侧面和底部均有1/4螺纹孔，可实现横竖拍摄。

装配磁吸扩展底座，可以让套件固定在大疆的磁吸球头组件和磁吸转接件上，实现相机的角度调节。（如右图示）

搭配DJI Action磁吸球头组件

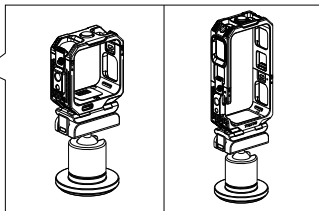
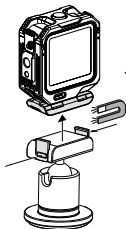

搭配DJI Action磁吸转接件

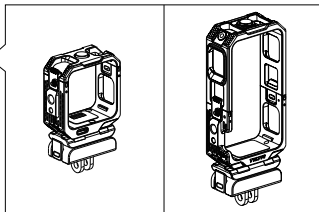
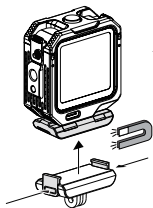

07 认识——滤镜拓展配件

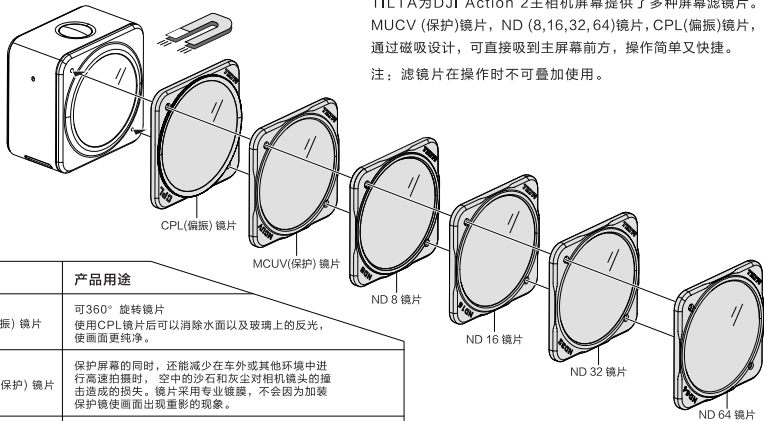

型号	名称	产品用途
TA-T26-CPL	CPL(偏振) 镜片	可360° 旋转镜片 使用CPL镜片后可以消除水面以及玻璃上的反光, 使画面更纯净。
TA-T26-MUCV	MUCV(保护) 镜片	保护屏幕的同时, 还能减少在车外或其他环境中进行高速拍摄时, 空中的沙石和灰尘对相机镜头的撞击造成的损失。镜片采用专业镀膜, 不会因为加装保护镜使画面出现重影的现象。
TA-T26-NDS	ND(8/16/32/64) 镜片套装	4种不同值的ND镜, 可应对不同的场景的拍摄, 如雪地/跳伞/潜水等特殊场合。

08 **DISCLAIMER AND WARNING**

Thank you for choosing Tilta products. This content has been created in regards to your safety, responsibilities, and legal rights as the customer. Please carefully read the text prior to using the product to ensure that you fully understand the correct procedures and safety precautions before use. Tilta technology CO., Ltd. reserves the right to final interpretation of this content and other related information. Potential updates to the product may occur without prior notice. Please visit www.tilta.com for the latest product information.

Please do not carry out any unauthorized repair to Hydra Alien Car Mounting System or change its mechanical structures. Any unauthorized operation may cause damage to the product. Tilta technology Co., Ltd will not take responsibility for any damage that was caused by unauthorized operation.

By using this product, you will be regarded as understanding this disclaimer as well as accepting of all policies and regulations put forth by Tilta technology Co., Ltd.

Tilta is a registered trademark that belongs to Tilta technology Co., Ltd and its subsidiary company. All product and brand names that are mentioned in this content belong to Tilta technology Co., Ltd and its subsidiary company.

09 SINGLE CAMERA CAGE

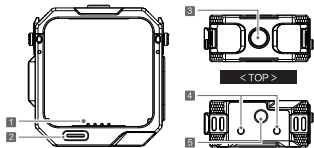

< BACK >

< BOTTOM >

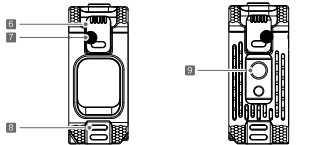

< LEFT SIDE ARM >

< RIGHT SIDE ARM >

- | | | |
|----------------|-----------------------|---|
| 1 Power port | 4 M3 screw hole | 7 Release button |
| 2 USB-C port | 5 1/4" -20 screw hole | 8 Strap holder |
| 3 Power/Record | 6 Lock | 9 1/4" -20 screw hole with locating point |

DEMONSTRATION

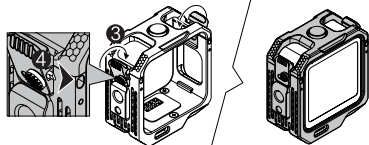
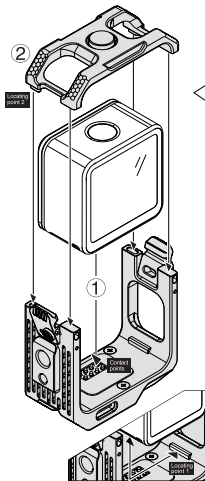

Align the **contact points** and **locating point 1**, and place DJI Action 2 camera into the single camera cage ①. Align the **locating point 2**, and mount the top cover ②. Press the latch and slide the release button ④ (shown as in graph 3) to secure the latch. To disassemble, release the release button and unlock the latch.

细节展示

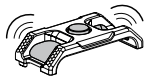

The built-in heat conductive silicone mats on the top and the bottom guarantee quicker cooling. The power button on the top of the cage provides easier operation. The hollowed-out side opening guarantees uninterrupted WIFI signal.

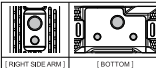

[RIGHT SIDE ARM]

[BOTTOM]

1/4" -20 screw holes are located on both the bottom and right side of the cage, allowing you to mount to tripods, adjustable mounting brackets, etc. It also supports direct mounting to a baseplate. Easily switch between horizontal and vertical modes. Reserved M3 screws for mounting GoPro baseplate.

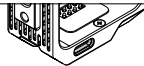

The back has a built-in USB-C port to allow for an external power supply for continuous shooting.

10 DUAL CAMERA CAGE

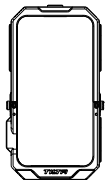

< FRONT >

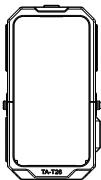

< BACK >

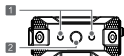

< BOTTOM >

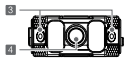

< TOP >

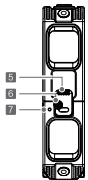

< LEFT SIDE ARM >

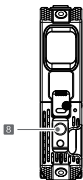

< RIGHT SIDE ARM >

- 1 M3 screw hole
- 2 1/4" ~20 screw hole
- 3 M3 screw hole
- 4 Power/Record
- 5 Latch
- 6 Release button
- 7 Audio port
- 8 1/4" ~20 screw hole with locating point

DEMONSTRATION

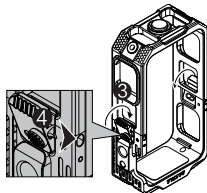
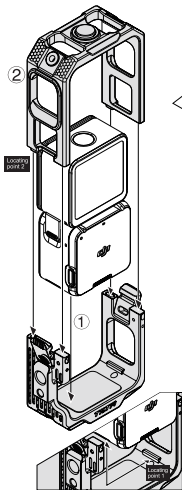

Align the USB-C port and **locating point 1**, and place DJI Action 2 camera and the front touchscreen module into the dual camera cage ①. Align the **locating point 2**, and mount the top cover ②. Press the latch and slide the release button ④ (as shown in graph 3) to secure the latch. To disassemble, release the release button and unlock the latch.

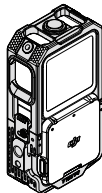

DETAILS

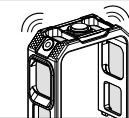

The built-in heat conductive silicone mats on the top and the bottom guarantee quicker cooling. The power button on the top of the cage provides easier operation. The hollowed-out side opening guarantees uninterrupted WiFi signal.



[TOP]



[BOTTOM]

The corners have 4 built-in M3 screw holes for mounting shock absorbing frame.

11

SHOCK ABSORBING FRAME

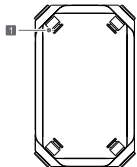

< FRONT/BACK >

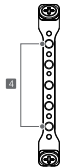

< LEFT SIDE ARM >

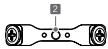

< TOP >

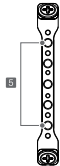

< RIGHT SIDE ARM >

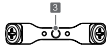

< BOTTOM >

1 Shock absorbing pad
[Reduces shock frequency]

2 3 4 5 1/4"-20 screw hole with locating points
[The built-in mounting points support horizontal and vertical shooting modes, and support installing accessories such as an additional LED light]

DEMONSTRATION

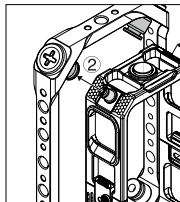
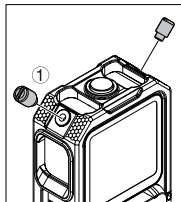
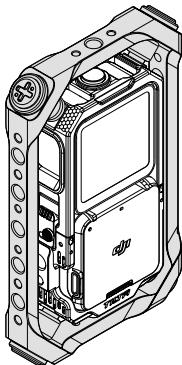

Insert the M3 screws into the M3 screw holes ① on the four corners of the dual camera cage (or shock absorbing camera cage). Push all M3 screws into the shock absorbing pads ②. Double check the security after the installation.

12 SHOCK ABSORBING FRAME SOFT CLAMPS

To shoot under high-speed driving conditions, use the shock absorbing frame soft clamps to secure the camera cage.

Attach the soft clamps ① onto the shock absorbing pads. Push and thread the four M3 screws into the shock absorbing pads on the ② shock absorbing frame kit.

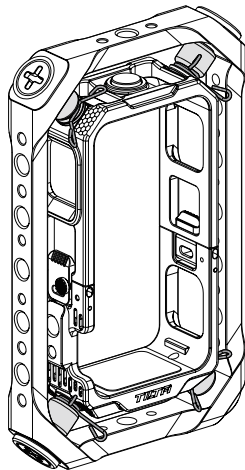
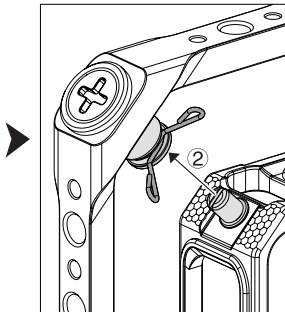
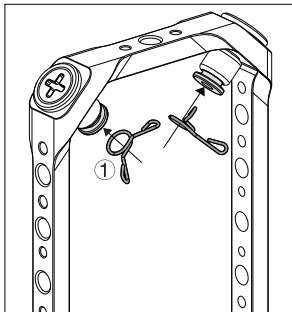

13 MAGNETIC BASEPLATE

The baseplate has a built-in magnet for easier installation.

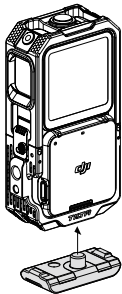
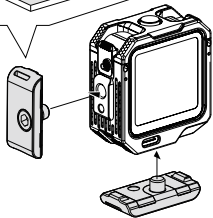
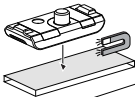

The magnetic baseplate can be installed under the single or dual camera cage. There are screw holes on the side and the bottom to support horizontal and vertical modes. After the magnetic baseplate is installed, the cage can be assembled to DJI magnetic kit and magnetic adapter, to achieve angle adjustment. (See picture on the right.)

WORKING WITH DJI ACTION MAGNETIC KIT

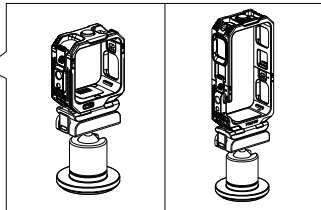
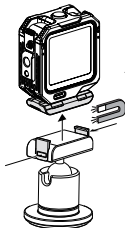

WORKING WITH DJI ACTION MAGNET ADAPTER

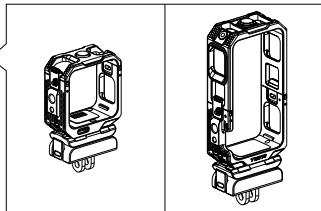
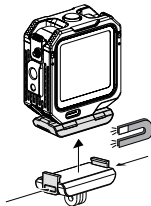

14 FILTERS

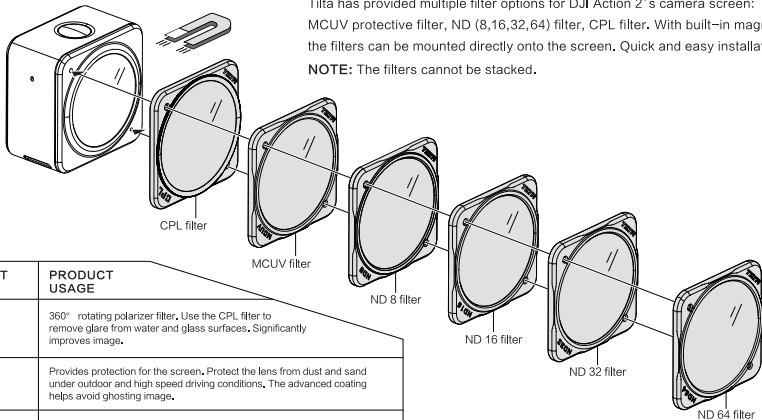

SKU	PRODUCT NAME	PRODUCT USAGE
TA-T26-CPL	CPL filter	360° rotating polarizer filter. Use the CPL filter to remove glare from water and glass surfaces. Significantly improves image.
TA-T26-MCUV	MCUV filter	Provides protection for the screen. Protect the lens from dust and sand under outdoor and high speed driving conditions. The advanced coating helps avoid ghosting image.
TA-T26-NDS	ND(8/16/32/64) filter set	4 levels of ND filters for different shooting scenarios, such as skydiving, scuba-diving, etc.

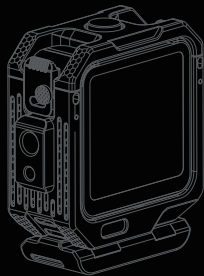
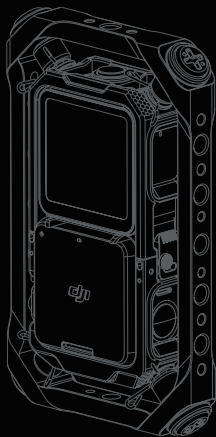

TILTA FOR DJI ACTION 2